



TELEFUNKEN
Elektroakustik

SDC Series

Microphone Product Manual

ELA M 260 • M60

Series Overview

The TELEFUNKEN Small Diaphragm Condenser Series features the vacuum tube-based ELA M 260 and the phantom-powered M60 FET microphones, both of which accept the thread-on TK6x Series capsules. Both amplifiers have their strengths, be it the ELA M 260's natural warmth and clarity or the M60's low self noise and ultra fast transient response. All assembly and testing of the Small Diaphragm Condenser Series occurs in TELEFUNKEN's American facility. Depending on the system configuration, different capsule combinations will be included. Please see the System Specifications for more information. Additional capsules and accessories are available for purchase directly from TELEFUNKEN.

Specification	ELA M 260	M60 FET
Amplifier Type	Tube (5840W)	FET
Frequency Range	20 Hz - 20 kHz, ± 3 dB	20 Hz - 20 kHz, ± 3 dB
Power Source	External Power Supply	+48V Phantom Power
Transformer	TELEFUNKEN Elektroakustik T60	TELEFUNKEN Elektroakustik T61CT
Sensitivity	19.5 mV/Pa, ± 1 dB	10 mV/Pa, ± 1 dB
THD at 1 kHz, 1 Pa	< 0.15%	< 0.01%
Output Impedance	200 Ω	120 Ω
Maximum SPL	135 dB	> 135 dB
S/N Ratio	83 dBA	89 dBA
Self-Noise	11 dBA	5 dBA
Dimensions	140 mm x 20 mm	140 mm x 20 mm
Weight	116 g	110 g

Capsule Specifications

TK6x Series interchangeable capsules feature a 15 mm diameter, 6-micron gold-sputtered membrane. They are designed to easily thread on and off the amplifier body. All TK6x Series capsules are held to a strict ± 1 dB sensitivity tolerance and individually tested and matched by frequency response in TELEFUNKEN's American facility.

TK60 Cardioid: Flat from 150 Hz to 7 kHz with a presence peak at 8 kHz, ideal for drum overheads, acoustic guitar, and other acoustic instruments.

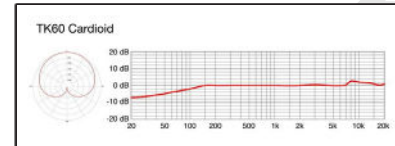

TK61 Omnidirectional: Flat from 20 Hz to 5 kHz with a presence peak at 8 kHz. Use with SD40 diffuse field spheres to make the upper midrange frequencies more directional.

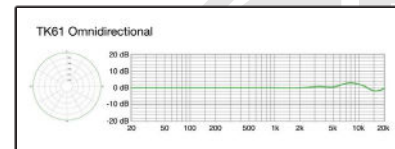

TK62 Hypercardioid: Flat from 150 Hz to 3 kHz with a dip at 6 kHz and a presence peak at 8 kHz, excellent for cymbals, percussion, and as a stereo pair for live performance recording.

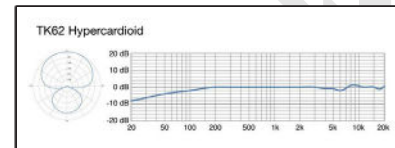

Additional capsules are available for purchase through the TELEFUNKEN Elektroakustik webstore: www.t-funk.com/shop

ELA M 260 Tube

One of the few small diaphragm tube microphones available today, the ELA M 260 is an absolute first choice for acoustic instrument recording. Everything from stringed instruments to drum overheads will benefit from the 260's perfect combination of small diaphragm precision and classic tube warmth. Its tonality and detail when capturing acoustic instruments, especially strings, brass, woodwind and percussion, is unrivaled. Hand-assembled in America, the ELA M 260 features a NOS 5840W vacuum tube, premium through hole components and an American-made transformer.

Quick Start Guide

1. Attach the included shock mount onto a microphone stand.
2. Push the microphone through both sets of elastics of the mount.
3. Plug the included 7-pin tube microphone cable into the microphone then into the power supply.
4. Make sure the power supply is set to the correct mains voltage (115V or 230V). Plug the included power cable into the power supply, then into mains power.
5. Connect a standard 3-pin microphone cable (not included) to the power supply and then to your microphone preamplifier input.
6. Turn on the power supply. Let the system warm up for 10 minutes before use.



ELA M 260 System Configurations

System	Cardioid	Master	Stereo	Master Stereo	Master Tri-Mono
TK60 Cardioid Capsule	X	X	2X	2X	3X
TK61 Omni Capsule		X		2X	3X
TK62 Hyper Capsule		X		2X	3X
M 963 Tri Power Supply					X
M 960S Dual Power Supply			X	X	
M 902 Power Supply	X	X			
M 860 Tube Microphone Cable	X	X	2X	2X	3X
M 761 Shock Mount	X	X	2X	2X	3X
ZC60 Zipper Case	X	X			
FC60S Flight Case			X	X	
FC60T Flight Case					X
SD40 Diffusion Sphere					3X
WS20 Windscreen	X	X	2X	2X	3X

Safety Warning: Vacuum tube microphones, their associated power supplies, and their cables carry potentially harmful voltages. Make sure all connections are made before powering on your microphone system. Do not open your microphone or power supply while it's connected to mains power and powered on. If your microphone stops working, turn it off and visit www.t-funk.com/repairs for information on repairing your product.

M60 FET

The M60 is a re-interpretation of the classic phantom-powered pencil mic, featuring exceptional transient response and high SPL handling capabilities. Paired with its impressive clarity and subtle tonality, the M60 excels at capturing acoustic and percussive instruments both in the studio and on the stage. The M60 is hand-assembled in America using premium components and utilizes an ultra-clean, true class-A discrete circuit paired with an American-made transformer. Its unique circuit topology captures a wide frequency range, which means life-like capturing of most sources.

Quick Start Guide

1. Attach the included shock mount onto a microphone stand.
2. Push the microphone through both sets of elastics of the mount.
3. Plug the included SGMC-5R 3-pin XLR cable into the microphone then into your microphone preamplifier input.
4. Apply +48V phantom power from your microphone preamplifier. Allow the microphone 15 seconds to power up before use.



M60 System Configurations

System	M60	M61	M62	Master	Stereo	Master Stereo
TK60 Cardioid Capsule	X			X	2X	2X
TK61 Omni Capsule		X		X		2X
TK62 Hyper Capsule			X	X		2X
M 761 Shock Mount	X	X	X	X	2X	2X
SGMC-5R XLR Cable	X	X	X	X	2X	2X
ZC61 Zipper Case	X	X	X	X		
ZC62 Dual Zipper Case					X	X
ZC63 Tri Zipper Case						
WS20 Windscreen	X	X	X	X	2X	2X

Operating Conditions

Because the M60 is a phantom-powered microphone, a +48V source is necessary for operation. Phantom power is provided through most mixers, consoles, and preamplifiers as a standard feature. Please note that the microphone should be muted when engaging phantom power, as it can produce a loud pop as it turns on.

Recommended Stereo Configurations

ORTF: Use TK60 Cardioid capsules. Angle the two microphones 110 degrees apart with the capsules spaced 17 cm. ORTF is designed to mimic the placement of the human ears.

A/B or Spaced Pair: Use TK60 Cardioid or TF61 Omnidirectional capsules. Position the two microphones parallel to each other. Recommended spacing is 60 cm, though spacing up to 3 meters can be used depending on the distance from the source, the environment, and the desired stereo width.

XY: Use TK60 Cardioid or TK62 Hypercardioid capsules. Angle the two microphones 90 degrees apart with the center of the capsules directly over each other. The capsules should be as close as possible without touching. This technique will sound more direct than other techniques listed and should always be phase coherent.

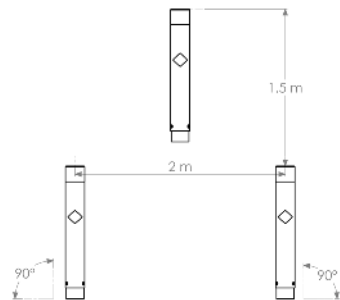
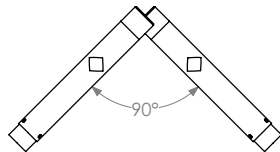
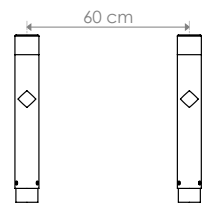
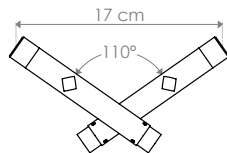

Decca Tree: Use TK61 Omnidirectional capsules with SD40 diffuse field spheres. Position the Left and Right microphones 2 meters apart, with the Center microphone 1.5 meters in front. Distances can be adjusted but should not be less than 1.5 meters. The Left and Right microphones can be angled outwards up to 90 degrees.

Tips:

1. Remember to check for phase cancellation!

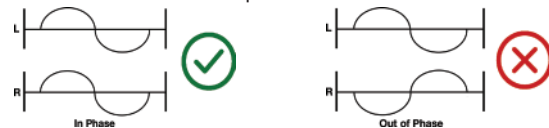

2. Cardioid capsules will lose low end with distance, while Omnidirectional capsules will retain low frequency information.

3. Omnidirectional capsules will pick up more ambient noise, so Cardioid and Hypercardioid capsules are recommended for less than ideal recording environments.

Warranty

TELEFUNKEN Elektroakustik warrants that any capsules and tubes used in their microphones are free from defects in material and workmanship for the period of ninety (90) days from the original date of purchase, and agree to replace any capsule or tube which, under normal installation and use, disclose such defect. This is provided that the complete microphone is delivered to TELEFUNKEN Elektroakustik intact for examination and provided that such examination discloses, in the judgment of TELEFUNKEN Elektroakustik, that the tube or capsule is indeed defective. Upon replacement, TELEFUNKEN Elektroakustik will provide an additional 90-day limited warranty on the new capsule or tube.

This warranty does not extend to any capsule or tube which appears to have been misused, altered, neglected, damaged, or stored in any manner that adversely affects it, or used in violation of instructions furnished by us. This limited warranty shall be void and of no further force or effect whatsoever if the microphone is repaired or modified by any person other than an authorized representative of TELEFUNKEN Elektroakustik. This warranty shall not apply to any defect, failure, or damage caused in whole or in part from attempts by personnel other than TELEFUNKEN Elektroakustik's to open, repair, or service the microphone; nor to damage to a unit which has been modified by persons other than TELEFUNKEN Elektroakustik personnel.

In compliance with the following requirements:

EMC Directive: 2014/30/EU (EN 55013 applied)

Low Voltage Directive: 2014/35/EU (EN 60065 applied)

RoHS2 Directive: 2011/65/EU



Product Registration

All TELEFUNKEN Elektroakustik customers are encouraged to register recently purchased NEW or USED products. All warranties on Diamond, Alchemy, and SDC Series products are fully transferable between owners for the length specified for each series starting from the date the microphone was purchased as new.

Microphones come with a 90-day warranty for capsule and tube. A one-year warranty covers parts and labor on the amplifier as well as the power supply. Upon registering your new products, the warranty will be increased to one year parts and labor for the capsule and tube, and four years for the amplifier and power supply.

To register your warranty, please head to www.t-funk.com/warranty to fill out the Product & Warranty Registration form.

Repairs & Service

Repairs on new TELEFUNKEN Elektroakustik microphones are covered under a limited warranty plan and repair costs will be determined based upon the date of purchase and the date in which the warranty was registered. Repairs & Service covered under the warranty plan are done at no charge for labor, parts and service.

Please visit www.t-funk.com/repairs for more information on repairing your TELEFUNKEN microphone.

Diamond Series



Dynamic Series & Drum Packs



Alchemy Series



Direct Boxes



Tubes, Accessories, Merch & More!



www.t-funk.com

300 Pleasant Valley Rd, Suite C
South Windsor, CT 06074

+1.860.882.5919



Elektroakustik